

# PKG-174-DPE-CBL

## System Diagram and Specifications

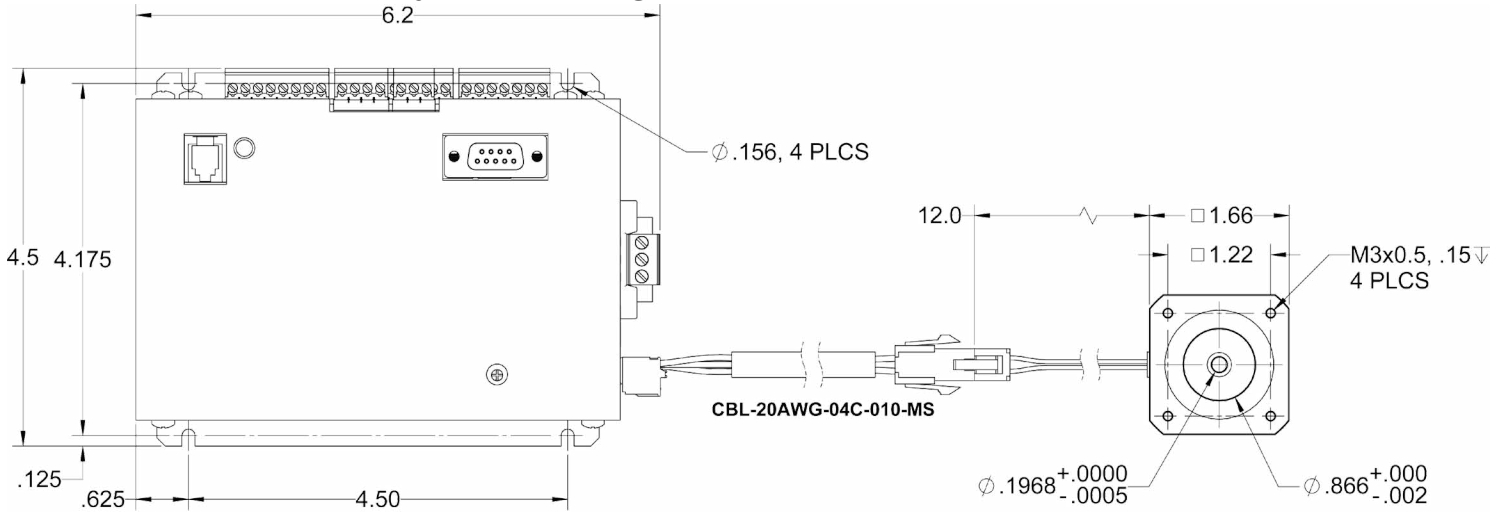

**DPE25601  
DRIVER PACK w/ PROGRAMMABLE INDEXER**

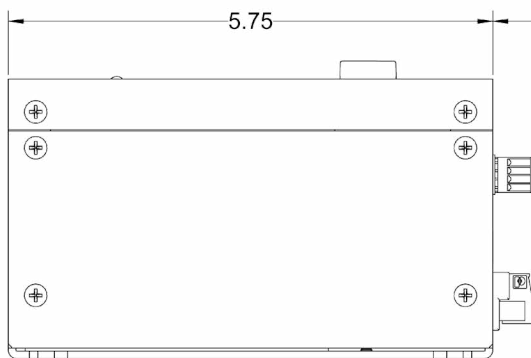

**NEMA 17 STEPPER MOTOR**

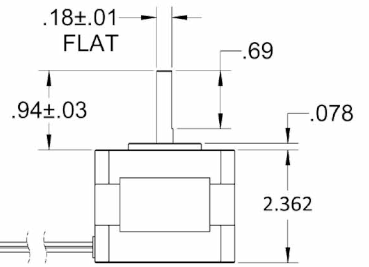

### Included Components:

17Y402S-LW4-MS	Stepper Motor
DPE25601	2.5Amp Driver Pack with Programmable Indexer
CBL-20AWG-04C-010-MS	Motor Cable

**17Y402S-LW4, DPE25601, Div by 8, Series**

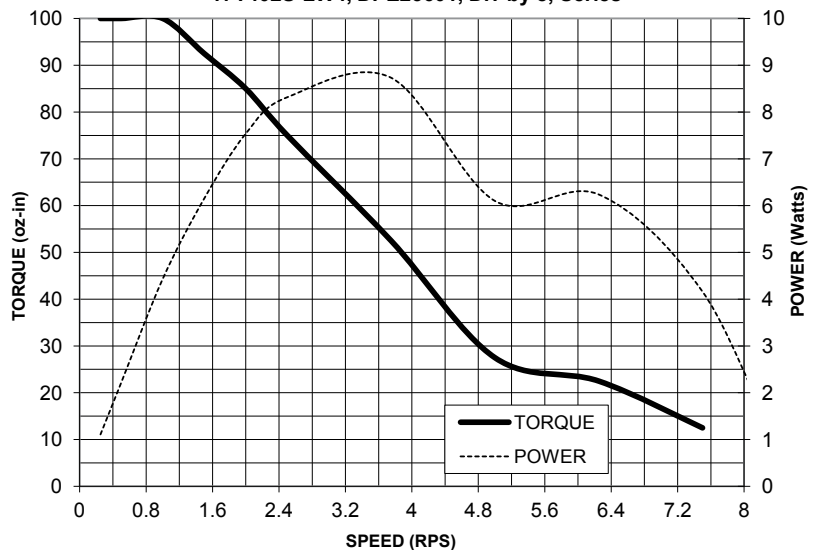

L010878

# 17Y402S-LW4-MS - High Torque Stepper Motor

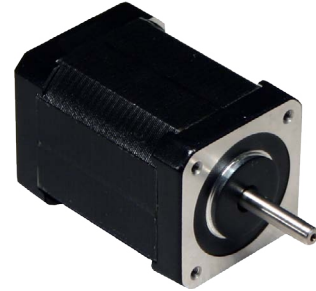

FEATURES

- **NEMA 17 Frame Size**
- **Holding Torque - 111 oz-in**
- **1.8° Step Angle**
- **High Step Accuracy and Resolution**
- **Low Vibration and Noise**
- **CE Certified RoHS Compliant**

The 17Y402S-LW4-MS High Torque Stepper Motor offers a great value without sacrificing quality. This motor was designed to offer the highest possible torque while minimizing vibration and audible noise. It is wired in series with a Molex 4 pin Mini-Fit Jr. receptacle.

A 10 ft. 4 conductor, 20 AWG cable with mating 4 pin Mini-Fit Jr. plug is included in the PKG-174-DPE-CBL stepper motor/driver package.

SPECIFICATIONS

Model #	NEMA Size	Bipolar Torque (oz-in)	Bipolar Voltage (v)	Bipolar Resistance (ohms)	Bipolar Current (A)	Bipolar Inductance (mH)	Rotor Inertia (oz-in-sec <sup>2</sup> )	Shaft Diameter (in)	Weight (lbs)	Length (in)
17402S-LW4-MS	17	111	12.00	10.20	0.85	29	0.00144	0.197	1.10	2.36

Specifications			
Step Angle Accuracy:	± 5% (Full Step, No Load)	Insulation Resistance:	100M Ohm Min, 500VDC
Resistance Accuracy:	± 10%	Dielectric Strength:	500VDC for 1 minute
Inductance Accuracy:	± 20%	Shaft Radial Play:	0.02" Max (1.0 lbs)
Temperature Rise:	80°C Max (2 Phases On)	End Play:	0.08" Max (1.0 lbs)
Ambient Temperature:	-20° to +50° C	Max Radial Force:	16.3 lbs

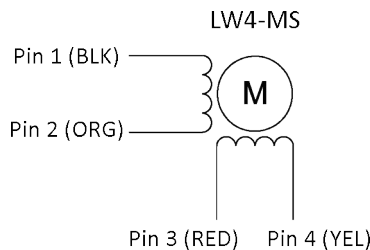

Pin #	Lead Wire Connection	Lead Wire Color
1	Phase 1 (A)	Black
2	Phase 3 (A)	Orange
3	Phase 2 (B)	Red
4	Phase 4 (B)	Yellow

# DPE25601 - 2.5Amp Stepper Driver Pack With Programmable Indexer



## Table of Contents

<b>Section 1: Introduction</b> .....	<b>4</b>
Description.....	4
Electrical Specifications.....	5
Wiring Diagrams .....	5
Terminal Descriptions - Driver .....	6
Motor Ground .....	6
Terminal Descriptions - Controller .....	7
Connector Descriptions - Controller .....	7
Slide Switch Descriptions - Controller .....	7
<b>Section 2: Driver Functions</b> .....	<b>8</b>
Microstep Selection - Driver DIP Switch Settings.....	8
Setting the Output Current.....	9
Reducing Output Current.....	9
Short-Circuit, Mis-Wire, and Over-Current Conditions .....	9
<b>Section 3: Controller Functions</b> .....	<b>10</b>
Methods of Communication.....	10
Baud Rate.....	10
RS232 Protocol - Controller SW1 in RS232 position.....	10
RS485 Protocol - Controller SW1 in RS485 position.....	10
Axis Selection.....	11
Controller Status LED.....	11
Technical Support.....	11
<b>Section 4: SMC60WIN Software</b> .....	<b>16</b>
File Menu.....	17
Setup Menu .....	17
Setup - Axis Menu .....	17
Program Menu.....	18
Program - Autostart Program Menu.....	18
Edit Menu .....	18
Help Menu .....	19
“The Unit is Connected” / “The Unit is NOT Connected” .....	19
Toolbar.....	20
Tab Sheets.....	20
Add/Change/Insert Commands .....	25
Calculator .....	30
<b>Section 5: Direct Talk Mode</b> .....	<b>31</b>
<b>Section 6: Troubleshooting</b> .....	<b>41</b>
Error Codes .....	42
<b>Section 7: Sample Programs</b> .....	<b>43</b>
Appendix: ASCII Table for Direct Mode .....	45

## Section 1: Introduction

The DPE25601 is a single-axis 2.5A bipolar microstep driver/controller, containing 2 Kbytes of nonvolatile stored programming space, quadrature encoder feedback, and a 24W power supply, all enclosed in a package. It provides flexible, independent control of bipolar stepper motors with a current range from 0.5 to 2.5 amps/phase with a microstepping resolution of 1600 steps per revolution from a computer or any machine controller with a serial port. It is also capable of standalone operation, making it an embedded machine controller. The easy to use Windows software, SMC60WIN, can be used to directly control motion and to program the DPE25601. The DPE25601 also has the ability for real time functions.

The DPE25601 has 40 commands, which are easy-to-remember for direct movement of the stepper motor and communicates via either an RS232 or RS485 bidirectional serial data bus. Up to 99 DPE25601's can be networked from one communications port on your PC or PLC, utilizing the RS485 communications protocol. Special functions of the controller include 8 programmable open collector outputs and 6 TTL, CMOS and 24V compatible inputs, a quadrature encoder input with the ability to autocorrect, an analog input to control either maximum speed or absolute position, registration mark indexing during a slew command, an output that will trigger during an index command at an absolute position, and a thumbwheel input for indexing a motor. The DPE25601 can be powered from 100-240 VAC, 50/60Hz,

### Description

The driver in the DPE25601 (MBC25081) is a microstep motor driver that can drive motors rated from 0.5 to 2.5 amps/phase. It can handle 4, 6 and 8-lead motors in a bipolar fashion. The DPE25601's driver features motor current ON/OFF capabilities and a Reduced Current Enable to automatically reduces motor current to 50% of the set value after the last step is made (20msec delay).

The controller in the DPE25601 (PCL601) provides independent programming of acceleration/deceleration, base speed (start up speed), max speed (running speed), jog speed, and the number of steps to be taken in both relative and absolute positioning modes. On absolute positioning moves, the DPE25601 automatically determines the proper direction to go and the number of steps to take. The relative positioning will move a number of steps in the direction that the user defines. The DPE25601 also has specific functions such as *encoder feed back*, *autocorrection*, *index-on-the-fly* and *output-on-the-fly*. An analog input can be used to set either the maximum speed or goto an absolute position based between the upper and lower programmable limits. A seven decade thumbwheel switch can be read for relative indexing. The DPE25601 also has a high level programming command set that includes: branching, looping, conditional statements, time delays, text strings, and I/O which the user can use in the programming mode to fully control all machine functionality. A home input, a set of bidirectional hard and soft limit switch inputs and bidirectional jog inputs are provided for each axis. These features are generally required in most machine control designs. 6 testable TTL, CMOS and 24V compatible inputs and 8 programmable open-collector outputs are provided per axis. The I/O may be used for monitoring and controlling machine operation and/or interaxis coordination. The I/O are accessible independent of the busy state of the axis controls. The DPE25601 has a built-in programmable reset circuit. Reset is automatic on power-up, or by pressing the external reset button.

# Electrical Specifications

**Power Requirements:**  
100-240 VAC 50/60Hz

**Operating Temperature:**  
0 to 60 degrees C

**Pulse Output Range:**  
1 to 50,000 Hz (0 to 31.25 Rev/Sec)

**Inputs (TTL-CMOS):**  
Logic "0": 0 to 0.8VDC  
Logic "1": 3.5 to 24VDC  
Analog input 1: 0 to 5VDC

**Output Current Rating:**  
2.5 A/phase maximum running  
1.75 A/phase maximum standstill

**Baud Rate:**  
38400 Baud, Fixed

**Data Format:**  
Half-Duplex, 1 start bit, 8 data bits,  
no parity, 1 stop bit

**Outputs (8 programmable):**  
Open Drain Type  
40V, 100mA  
+5VDC Output, 50mA

**Output1 active low time for output on the fly:**  
50uS

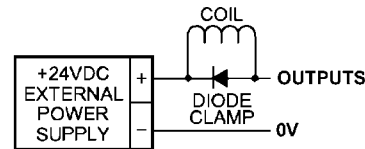

**Note:** For inductive loads, customers must connect a clamping diode to protect from flyback voltage spikes.

## Wiring Diagram

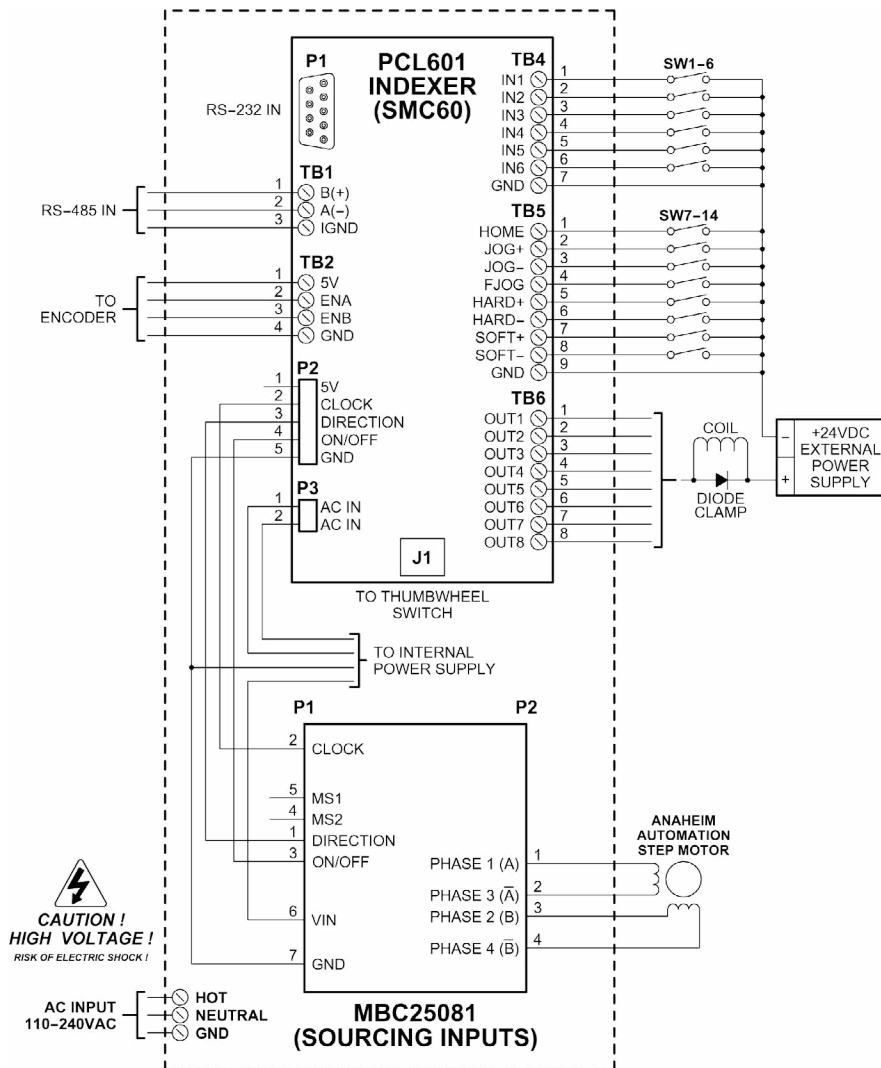

## Terminal Descriptions - Driver

Position	Description - Motor Connection
1	Phase A: Phase 1 of the Step Motor
2	Phase A: Phase 3 of the Step Motor
3	Phase B: Phase 2 of the Step Motor
4	Phase B: Phase 4 of the Step Motor

## Terminal Descriptions - Controller

Position	Description - RS485
1	A(-)
2	B(+)
3	IGND - This is an isolated ground for RS485 only

Position	Description - Limit Switch Inputs
1	Home Limit
2	Jog +
3	Jog -
4	Fast Jog
5	Hard Limit +
6	Hard Limit -
7	Soft Limit +
8	Soft Limit -
9	Ground

Position	Description - Outputs
1	Output 1 - Output on the fly output
2	Output 2
3	Output 3
4	Output 4
5	Output 5
6	Output 6
7	Output 7
8	Output 8 - Encoder Re-tries Error Output

Position	Description - Inputs
1	Input 1 - Analog input
2	Input 2 - Index on the fly input
3	Input 3
4	Input 4
5	Input 5
6	Input 6
7	Ground

Position	Description - Encoder
1	+5VDC supply for encoder
2	A channel for encoder
3	B channel for encoder
4	Ground return for encoder

## Connector Descriptions - Controller

Switch Number	Description
P1	This connector is for the RS-232 communication and is labeled RS-232.
J1	This connector is for the thumbwheel module and is labeled TWS.

## Slide Switch Descriptions - Controller

Switch Number	Description
SW1	This switch is used to select either RS232 or RS485.

## Section 2: Driver Functions

### Setting the Output Current

The output current on the DPE25601 is set by an onboard potentiometer. This potentiometer determines the per phase peak output current of the driver. **The specified motor current of .85A for the 17Y402S-LW4-MS (which is the bipolar value) is multiplied by a factor of 1.4 to determine the current adjustment potentiometer value of 1.2Amps or 35%.**

Peak Current	Potentiometer Setting	Peak Current	Potentiometer Setting
0.50A	0%	1.50A	50%
0.70A	10%	1.70A	60%
0.90A	20%	1.90A	70%
1.00A	25%	2.10A	80%
1.20A	35%	2.30A	90%
1.30A	40%	2.50A	100%

### Reducing Output Current

Reducing the output current is accomplished by setting switch 1 of the DIP switch to the ON position and occurs approximately 1 second after the last positive going edge of the step clock input. The amount of current per phase in the reduction mode is approximately 50% of the set current. When the current reduction circuit is activated, the current reduction resistor is paralleled with the current adjustment potentiometer. This lowers the total resistance value, and thus lowers the per Phase output current.

**WARNING!** Step motors will run hot even when configured correctly. Damage may occur to the motor if a higher than specified current is used. Most specified motor currents are maximum values. Care should be taken to not exceed these ratings.

**WARNING:** Do not connect or disconnect motor wires while power is applied!

## Section 3: Controller Functions

### Methods of Communication

There are two methods for sending commands to the DPN10601. One is to directly talk to the DPN10601 by using Direct Talk Mode. This is usually used with a computer or PLC (Programmable Logic Controller), where the computer or PLC gives the DPN10601 serial commands to off-load its processor. For example: A PLC can utilize its outputs to toggle the DPN10601's inputs and gain control of variable speeds, variable programs, variable distances, etc. Simply using the DPN10601 as the intelligent pulse generator, a PLC can remove some of the tasks that were not meant for ladder logic or any PLC processing time.

The second way to give commands to the DPN10601 is to use the software program SMC60WIN to either manually control, or to write and send programs. This method is used when the DPN10601 is the main controller. For example: A DPN10601 can replace simple motion control and replace I/O functional when minimal quantities of I/O are required to control specific machinery. Simple motion profiles that can operate with 6 or less inputs and 8 or less outputs can utilize a DPN10601 controller.

### Baud Rate

A term used frequently in serial data communications, a "baud" is defined as the reciprocal of the shortest pulse duration in a data word signal, including start, stop, and parity bits. This is often taken to mean the same as "bits per second", a term that expresses only the number of "data" bits per second. Very often, the parity bit is included as an information or data bit. **The DPN10601 accepts a baud rate of 38400 only.**

### RS232 Protocol - Controller SW1 in RS232 position

The DPN10601 is a DCE device, therefore it will transmit on pin 2 and receive on pin3 of the DB9 RS-232 connector . The RS232 serial communication mode is single ended. This means that for each signal there is one wire, and a common ground reference used by all the signals. The DPN10601 does not use handshaking, thus the CTS and RTS lines are internally connected, and the CD, DTR and DSR lines are internally connected inside the DPN10601. The signal line maintains levels of +5VDC to +15VDC and -5VDC to -15VDC. For a valid logic level in the controller, the voltage must be at least +/-3 volts. RS232 works at distances of up to 50 feet maximum. **RS232 is susceptible to electrical noise, and should not be used in noisy areas. Always use the shortest cable connection possible. NOTE: Keep controller wiring separated from motor cable/wiring.**

### RS485 Protocol - Controller SW1 in RS485 position

The RS485 protocol mode is as follows; On board receivers will remain in active mode indefinitely. Transmitters must be turned off when the unit is not sending data, to prevent the line from sending and receiving data at the same time. Therefore when the PC is transmitting data its driver will be turned on and each of the units connected will have their drivers off. If they are requested to send data back to the PC, the selected unit will turn it's driver on to send the data and then turn it off after it has completed transmission. Note: The above protocol is done internally between the converter and the DPN10601. The RS485 method of communication allows increased noise immunity and increased communication distance of up to 4000 feet without repeaters. RS485 repeaters allow an additional 4000 feet per repeater. The DPN10601 is designed for two wire configuration. The 2 wire configuration makes use of the tristate capabilities of RS485 to allow a single pair of wires to share transmit and receive signals for half duplex communications. This "two wire" configuration (note that an additional ground conductor must be used) reduces cabling cost. **NOTE: Keep control wiring separated from motor cable/wiring.**



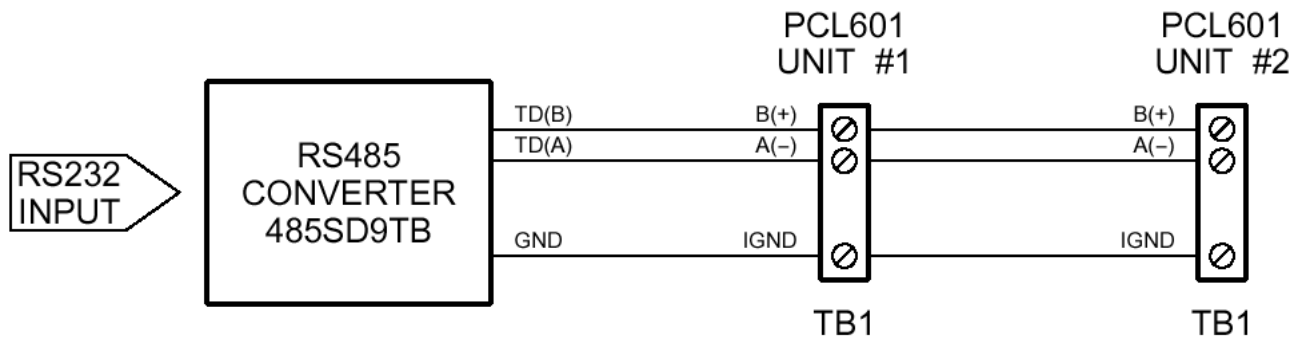

## RS232 to RS485 for multiple units or cables longer than 50ft

The DPN10601 can be connected to your PC serial port via a RS485 converter (*model number: 485SD9TB sold separately*). This converter will convert the RS232 voltage signals to the compatible RS485 differential signals. Only one converter box is needed per serial port. Contact the factory or use the website [www.anaheimautomation.com](http://www.anaheimautomation.com) for RS485 converter information and sales.

## Terminating Resistor

To eliminate noise on the transmission lines or when using a 4000 ft. or longer cable, a terminating resistor is suggested. If used, the termination resistor need only be added to the last (furthest from the converter box) DPN10601 in the network between pins A(-) and B(+) on the RS485 Terminal Block. The value of this resistor should be 120 ohms.

## Axis Selection

Each DPN10601 is addressed using a programmable register allowing the PC to address up to 99 DPN10601's from one port. The Default axis is "0". To change the axis, use the SMC60WIN software or the "~" command. To verify or check the axis, use the SMC60WIN software or the "%" command. The axis designation is nonvolatile and will remain the same until changed by the user.

## Controller Status LED

When powered and operated properly, the status LED will be green. When an error occurs, the LED will change to RED, and an error code will be generated in the error code register. To read and clear the error with the software, click on the "Verify Parameters" button located in the "Motion Tab". To read and clear the error while in "Direct Mode", use the error code "!" command. Once the error has been read and cleared, the LED will return to green and the error code register will be cleared to 0. Refer to the table on page 39 for a complete list of the error codes.

## Technical Support

Everyone needs assistance on occasion. If you have problems using any of the equipment covered by this manual, please read the manual to see if it will answer your questions. Be sure to look in the Troubleshooting Section located near the back of this manual. If you need assistance beyond what this manual can provide, you may call the factory direct for application assistance. If possible, have this manual in hand. It is often helpful to have the controller connected to a computer with the software installed.

**Move Number of Steps:** This command causes the motion to start in the direction last specified. This command will move the motor the number of steps given. (Range: 1 to 8388607)

**Move to Position:** The move to position command specifies the next absolute position to go to. The DPN10601 controller automatically sets the direction and number of steps needed to go to that position. (Range: -8388607 to +8388607)

**Slew:** The slew command will accelerate the motor up to maximum speed and continue to run at that speed until reaching a registration mark, hard limit switch, soft limit switch, receiving a “.” (stop hard) or “,” (stop soft) command.

**Set Position:** The set position command sets the position register to a designated value. The number will be the new absolute position of the motor. The default value is 0. (Range: -8388607 to +8388607)

**Limit Switch Inputs:** The limit switch inputs are internally pulled up by a resistor making them normally +5 volts. To activate the input, the pin must be grounded to (0VDC). All limit switch inputs are internally clamped to +5V, thus allowing voltages of upto +24VDC to be used.

**Hard Limit Inputs:** When a hard limit switch is encountered, the motion will stop immediately. The position counter will also cease counting. *Hard limits are intended as an emergency stop for your system. It should not be used to do any positioning type functions.* These limits are directional.

**Soft Limit Inputs:** These switches should be used exclusively for homing. Once positioned properly with the appropriate parameters, it causes the motor to ramp down to the base speed before encountering the home limit switch. However, the soft limit switch will work for any type of motion command. These limits are directional.

NOTE: Whenever a soft limit switch is activated, the motor will decelerate and run at base speed during an indexing move, or stop during a slewing move. Be sure to come back past the soft limit switch to set any origins, otherwise the motor will decelerate as it goes past the soft limit switch during normal operation.

**Home Limit Input:** This switch is used to establish a position designated “home” or datum position using the following: home to *soft and home limit*, or home to *home limit*. This limit is not directional.

**Home to Soft, Home Limit (2 Switch Operation):** This type of homing routine requires two grounding type limit switches called home and soft. The first limit switch seen is the soft limit. This will decelerate the motor down to base speed. The motor will then continue to run at base speed until it contacts the home limit switch input causing the motor to stop. The home limit switch activates as a hard limit if a soft limit is not sensed. The soft limit is directional, meaning that it will work in only one direction as specified. The soft limit switch will work for any type of motion command. The home limit switch will work only for the two home motion commands.

NOTE: There should be sufficient distance between the two limit switches, as to let the motor reach base speed.

**Home to Home Limit (1 Switch Operation):** This type of homing differs in that only one limit switch is needed. In this homing routine the motor moves toward the home limit switch. When the home limit switch is contacted the motor will ramp down to base speed, reverse direction and continue at base speed until the limit switch is released. This is a good way to compensate for any backlash in a system. It is also useful for minimizing the number of limit switches needed for homing.

NOTE: The home switch needs to be low during the entire deceleration and reversing time.

**Jog Inputs:** The jog switch inputs are internally pulled up by a resistor making them normally +5 volts. To activate the input, the pin must be grounded to (0VDC). All jog switch inputs are internally clamped to +5V, thus allowing voltages of upto +24VDC to be used. Jog is a manual function. The user can select the direction and speed (fast or slow) by grounding the appropriate combinations of inputs. To jog a motor, it is necessary to ground the jog input for the direction desired. For fast jog, both the fast input and jog input for the appropriate direction must be low at the same time. By grounding one of the jog inputs, the user causes the motor to run at base speed. When the fast input is grounded, the motor will then accelerate to the programmed jog speed. The position register will keep track of the number of steps that are taken during jogging. Once a +jog or a -jog function has been performed, the direction register will retain the last direction of movement; that is, a subsequent go command will be in the same direction as the last jog command.

**Inputs:** All inputs (except input 1) are internally pulled up by a resistor making them normally +5 volts. To activate the input, the pin must be grounded to (0VDC). All inputs are internally clamped to +5V, thus allowing voltages of upto +24VDC to be used. Six inputs are provided per axis. The inputs are TTL, CMOS and 24V compatible. The inputs may be used to initiate a machine cycle, for inter-axis coordination (in stored program mode), for operator intervention, for sensing a machine condition such as out of stock or wait for temperature to be reached, etc. A grounded input will read a “0” and an open or high input will read as a “1”. Input 1 is a special input that is capable of reading an analog voltage between 0 and +5VDC. Since this input does not have a pull-up resistor, biasing of this input is needed if it is not used as an analog input.

**Analog Input:** Input 1 can be configured to read an analog voltage to either set the absolute position of the motor or to set the maximum speed of the motor.

**To set the position,** when told via the *goto analog position* command, the input will read a voltage between 0 and +5VDC and based on the “upper and lower” limits of the function, a move will occur to a calculated position between the two limits. The motor must finish the move before it can be told to read the input again for the next position. For example, if the lower limit is set to 0 and the upper limit is set to 5000 and the analog position is set at +2.0VDC, then the motor will move to position 2000. Changing the lower limit to 1000 and the voltage to +3.2VDC, the motor will move to position 3560. See examples below for calculations of the analog inputs. (Range of limits: 0 to 65535 and the lower limit < upper limit)

**To set the max speed,** when told via the *set analog speed* command the input will read a voltage between 0 and +5VDC, and based on the “upper and lower” limits of the function, a max speed can be obtained based on a calculated frequency between the two points. The speed however can not be changed when the DPN10601 is busy (moving). See examples below for calculations of the analog inputs. (Range of limits: 0 to 50000 and the lower limit < upper limit)

**Analog calculations.**

$(Upper-Lower) * (Voltage/5) = X$   
 $Lower + X = Position \text{ or } Frequency$

**Example1:**

$(5000 - 0) * (2 / 5) = 2000$   
 $0 + 2000 = 2000$

**Example2:**

$(5000 - 1000) * (3.2 / 5) = 2560$   
 $1000 + 2560 = 3560$

**Outputs:** Eight outputs are provided per axis. Outputs may be used to operate relays, coolant valves, air cylinders, or, with the correct interfacing, any electronically controlled device. The outputs can drive all types of common peripheral power loads, including lamps, relays, solenoids, LED’s, printer heads, and heaters. For inductive loads, it will be necessary to connect a clamping diode (refer to specification section) from the output to the power source in order to provide adequate fly-back protection. The outputs are current sinking, open collector darlington. They are capable of sinking up to 100mA per output with voltages up to 40VDC. Turning an output on will pull the output pin to ground and turning an output off will make the output pin open. Output 1 has a special function (*output on the fly*) that will enable it to be triggered at a certain absolute position during a move. Output 8 has a special function that will trigger when the encoder retries function fails.

**Output on the fly:** This special function enables output 1 to turn on during a relative index or absolute move. There are three critical portions of information needed to make this function work correctly. First, output 1 will turn on (0VDC) for a preset delay of 50uS at a specific absolute position set by the *1st output position* command. Second, the output can then repeat this after a preset amount of steps set by the *number of steps between outputs* command, and third a predetermined amount of times to set the output is required by the *number of outputs* command which determines the preset amount of times to trigger the output. So if you start at position 0 and want to move to an absolute position of 10,000, you can set output 1 to turn on at position 2000, and every 1000 steps after that 5 times. So at position 2000, 3000, 4000, 5000, and 6000 output 1 will turn on for 50uS. To only have the output turn on at one position set both the “*number of steps between outputs*” and the “*number of outputs*” commands to 0. This function must be enabled, and will only work during a relative index or absolute position move. The output will trigger while going in either direction. If you do not want the output to trigger in the negative direction, the function must be turned off before the index move is started.

**Index on the Fly:** This special function uses Input 2 when a motor is slewing to move a predetermined amount of steps, set with the registration index command, before stopping. This function must be enabled, and will only work during a slew move. The registration index must be set before movement begins. (Range: 1 to 8388607)

**End of Program:** The end of program command, used within a stored program, stops execution of the program. This command must be used at the end of all programs.

**Wait:** In stored program mode, the wait command pauses the program for the specified number of milliseconds. (Range: 1 to 65535)

**If/Then Statements:** The if/then statements are conditional based on the values preset in the program. The user can either test each individual input or all inputs at once. If the input or input register matches the given value or values, then the program will execute the next line. If the input or input register does not match the given value, the program will skip the next line and execute the following line. An open input is read as a 1, and a grounded input is read as a 0.

**Branching or Goto Statements:** The goto instruction will have the program jump to the given label. If no label is in the program, it will error when trying to send.

**Return from Subroutine:** This function can be placed anywhere in the program as long as a goto statement has been already executed. The program will jump back to the last goto statement encountered and execute the next line in the program.

**Inner and Outer Loop:** The loop instructions allow the user to loop a program a variable number of times. The program will loop to the designated label location of the program. However, the label must always be at a lower line number than the loop instruction itself. You can only nest inner loops inside an outer loop. You may not nest an inner loop inside an inner loop, or an outer loop inside an outer loop. Multiple nested inner loops are allowed in one outer loop.

**Finish Move:** When writing a program, the finish move command is used directly after every motion command. When using this command, the DPN10601 internally generates a busy signal and will wait until the move is complete before executing any further commands. Unless the finish move command is used, the DPN10601 will continue to execute the program. If it encounters a command that cannot be used when the motor is moving, the DPN10601 will error and stop the program prematurely.

**Repeat Last Move:** This command will move the motor the number of steps given in the last indexing move. This command will not work correctly if the encoder autocorrect function is enabled.

**Encoder Commands:** The DPN10601 controller is capable of using a quadrature incremental encoder with A and B channels.

**Encoder Auto Correct:** This command will enable or disable the encoder feature of the DPN10601. When enabled, the encoder function will compare the desired position with the actual encoder position. If it is not in the correct position a correction move will be made.

**Encoder Delay:** This sets the wait time, which is a specified number of milliseconds after a relative index or absolute move is finished, prior to reading the encoder. This is used to remove the ringing that might be associated with the mechanics of the system. (Range: 0 to 65535)

**Encoder Motor Ratio:** This represents the ratio for the number of encoder pulses to one motor step. This ratio must be a whole number. For example, given a 1000 line quadrature encoder and a 400 step/revolution motor, the motor ratio is  $(1000 * 4) / 400 = 10$  (Range: 1 to 255 and must be a whole number)

**Encoder Retries:** This is the number of times the DPN10601 will try to autocorrect the motor shaft position before producing an error. When the error is produced, Output 8 is triggered. (Range: 0 to 255)

**Encoder Window:** This is the allowable error in encoder pulses (either plus or minus) from the desired position that is allowed before the motor autocorrects. (Range: 0 to 255)

**Thumbwheel Index:** This special function allows a thumbwheel with up to 7 decades to be used with the DPN10601 to set a relative index.

**Acceleration/Deceleration:** The acceleration and deceleration are the same value. The acceleration is entered directly as steps/sec<sup>2</sup> and controls the time that the motor will take to move from base speed to max speed, and from max speed to base speed. The higher the value, the faster the motor will accelerate. The same principal applies for the deceleration which is controlling the time it takes to go from the max speed to base speed. (Range: 100 to 9,999,999)

**Base Speed:** The base speed is the speed at which motion starts and stops. It is entered directly as the number of steps per second. This speed must always be less than the max speed and jog speed. (Range: 1 to 5000)

**Max Speed:** The max speed is the top speed the user wants the motor to run. This speed must always be greater than the base speed. It is entered directly as the number of steps per second. (Range: 1 to 50000)

**Jog Speed:** The jog speed sets the fast jog rate. Jog (+/-) is used to run at base speed. The FJOG pin, when grounded, will ramp the motor to the set jog speed. This speed must always be greater than the base speed. It is entered directly as the number of steps per second. (Range: 1 to 50000)

**Motor Current:** This command will control the on/off output which is designed to connect to the on/off input of Anaheim Automation's step motor drivers. To energize and allow current to flow through the coil of the motor, set the value to on. To de-energize and turn the current off to the motor, set the value to off. This is a dedicated output and not controlled with the output register.

**Verify:** The verify command causes the DPN10601 controller to send data back to the PC or PLC. The data is sent as an ASCII decimal string followed by a carriage return and a line feed.

## Section 4: SMC60WIN Software

The SMC60WIN software is a handy utility that supports Anaheim Automation's line of DPN10601's step motor controllers. Connecting your PC to the DPN10601, via a serial cable, the SMC60WIN software can easily perform the following tasks:

- Exercise and monitor the DPN10601 controller
- Write and edit stored programs for standalone operation
- Directly communicate with the DPN10601 controller

### Installation Software

The SMC60WIN can be downloaded from <http://www.anaheimautomation.com/software/smc60win201.zip>, containing the setup program for the SMC60WIN software, DPN10601 manual and sample programs.

SMC60WIN is compatible with all versions of Windows including Windows 2000, Windows XP and Windows 7.

#### Windows 2000/XP/Win 7 Installation

- 1) Open Windows Explorer
- 2) Navigate to the download location of smc60win201.zip
- 3) Extract the files from the compressed file into a new folder
- 4) Double click the Setup Icon in the created folder

### Getting Started

- 1) Double click on the SMC60WIN icon to run the SMC60WIN software.
- 2) Apply power to the DPN10601 controller.
- 3) Set the appropriate com port setting by selecting Setup | Com Port Settings from the menu bar (Ctrl+M is a shortcut)
- 4) Set the appropriate axis setting by selecting Setup | Axis from the menu bar. (Ctrl+A is a shortcut)
- 5) Establish communications with the DPN10601 by clicking on the Connect Icon, or select Setup | Connect from the menu bar. If the unit is connected properly, the program will notify you when communications has been established. (Ctrl+C is a shortcut)

## File Menu

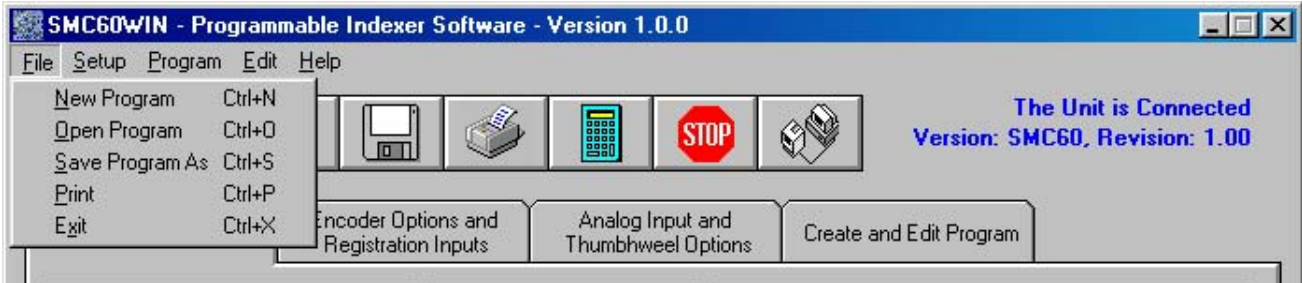

<u>N</u> ew Program	Start editing a new program.
<u>O</u> pen Program	Open an existing program from disk.
<u>S</u> ave Program As	Save the current program to disk.
<u>P</u> rint...	Print the current program.
<u>E</u> xit	Exit the SMC60WIN software.

## Setup Menu



<u>C</u> onnect	Establish communications with the controller.
<u>D</u> isconnect	Release the COM port for other devices to use.
Com <u>P</u> ort Settings	Select COM port.
<u>A</u> xis	Set axis selection and stored axis of the controller.

## Setup - Axis Menu



<u>S</u> elect Axis	Sets the axis select parameter in the SMC60WIN software. (1-99)
<u>D</u> efine Axis	Sets the programmable address in the controller. (1-99)

## Program Menu

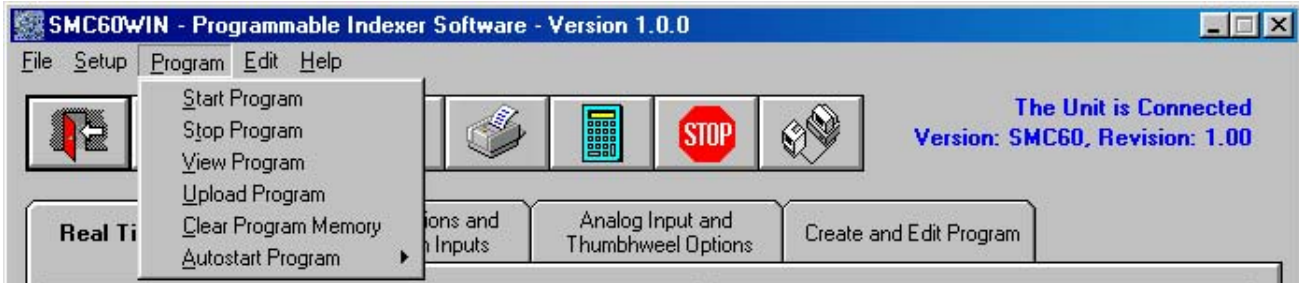

<u>S</u> tart Program	Start the execution of the program in the controller memory.
<u>S</u> top Program	Stop the execution of the program in the controller memory.
<u>V</u> iew Program	View the program stored in the controller memory.
<u>C</u> lear Program Memory	Clear the program memory in the controller.
<u>A</u> utostart Program	Turn the autostart function on or off.

## Program - Autostart Program Menu



<u>D</u> isable	Program will disable the execution of a stored program at power up.
<u>E</u> nable	Program will start execution when controller is powered up.

## Edit Menu

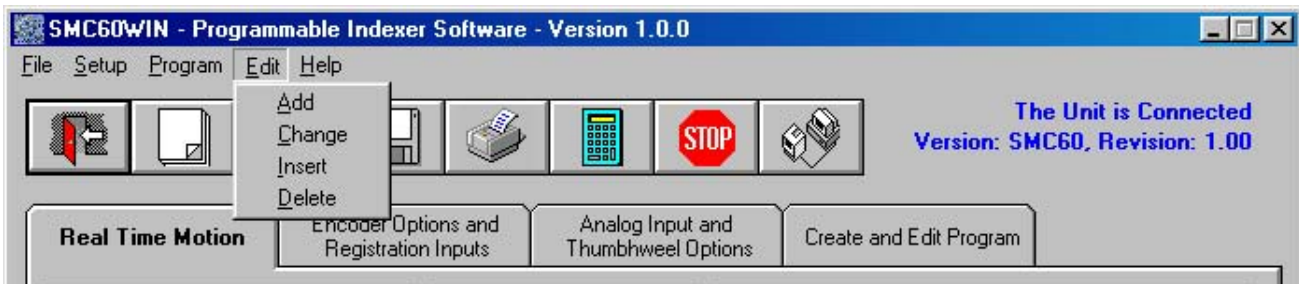

<u>A</u> dd	Adds a new line of code to the end of the program.
<u>C</u> hange	Edits the currently selected line of code.
<u>I</u> nsert	Insert a new line of code before the currently selected line of code.
<u>D</u> elete	Deletes the currently selected line of code.



## Help Menu

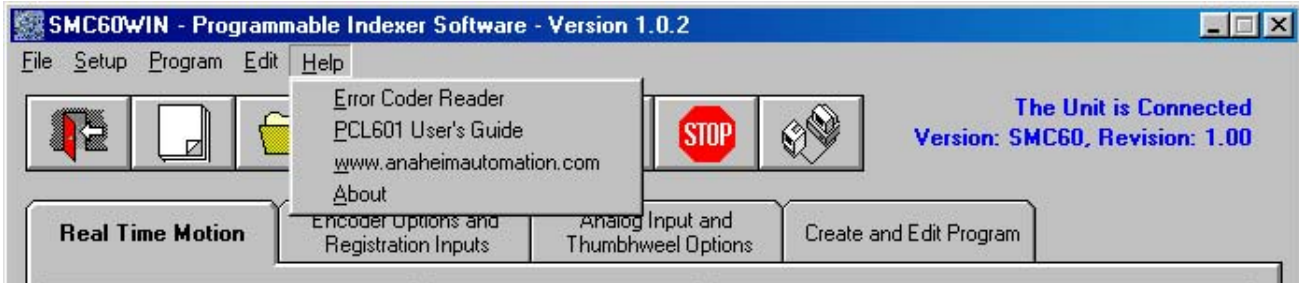

<u>E</u> rror Coder Reader	Utility to read the error code generated by the DPN10601 controller.
<u>P</u> CL601 User's Guide	Opens up the User's Guide in .pdf format.
<u>w</u> ww.anaheimautomation.com	Opens up the Anaheim Automation Website.
<u>A</u> bout	Displays the version of the SMC60WIN and contact information.

### “The Unit is Connected” / “The Unit is NOT Connected”

On the right of the Toolbar, the user will find the communication status of the DPN10601 controller. If communications are not established, please refer to the Troubleshooting Section.



## Toolbar

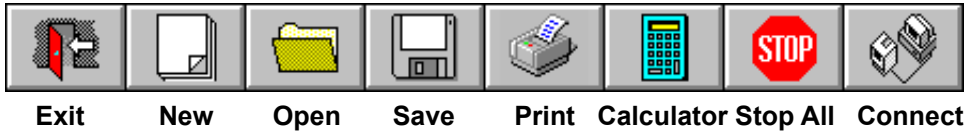

Exit	New	Open	Save	Print	Calculator	Stop All	Connect
Exit	Exit the SMC60WIN software.						
New	Start editing a new program.						
Open	Open an existing program from disk or directory.						
Save	Save the current program to disk or directory.						
Print	Print the current program.						
Calculator	Open the desktop calculator.						
Stop All	Stop the program and all motion from running.						
Connect	Establish communication with the controller.						

## Tab Sheets



Real Time Motion	Monitor and control motion of the controller.
Encoder Options and Registration Inputs	Monitor and change settings for encoder options, input on the fly and output on the fly.
Analog Input and Thumbwheel Options	Monitor and change settings to Analog Inputs and the thumbwheel switches.
Create and Edit Programs	Write and edit DPN10601 stored programs.

# Tab Sheets - Real Time Motion

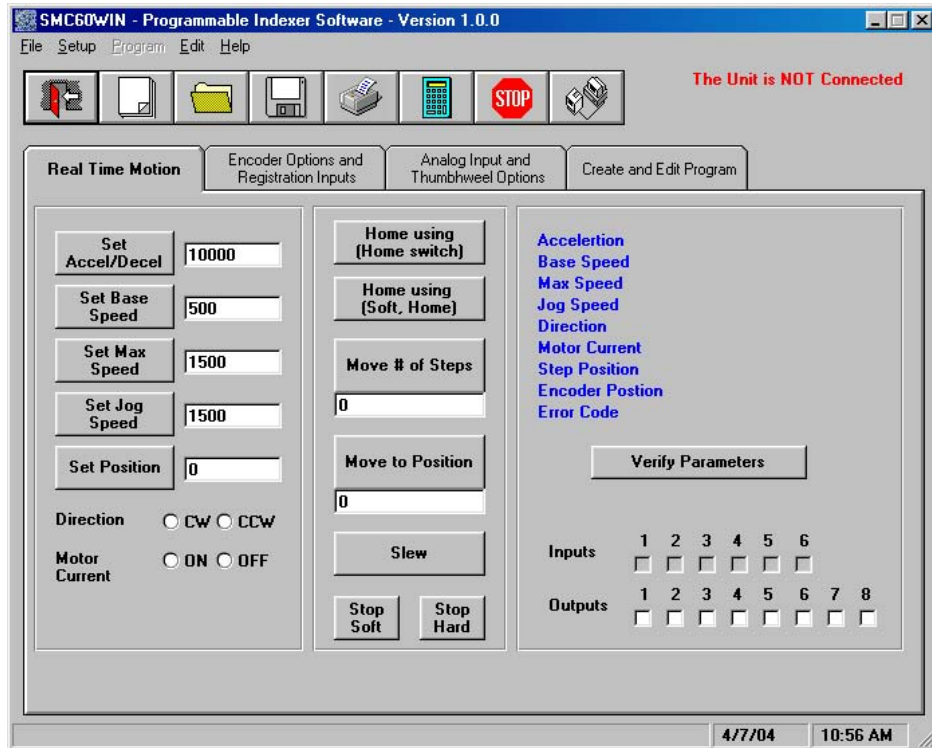

Set Accel/Decel	Send acceleration & deceleration parameter to controller. (step/sec <sup>2</sup> )
Set Base Speed	Send base speed parameter to the controller. (step/sec)
Set Max Speed	Send maximum speed parameter to the controller. (step/sec)
Set Jog Speed	Send fast jog speed parameter to the controller. (step/sec)
Set Position	Set motor position.
Set Direction	Set direction to clockwise or counter-clockwise.
Set Motor Current	Set the current in the motor on or off.
Home using Home Switch)	Motor will seek the home position by moving towards home switch which will stop the motor, reverse the motor direction and stop when the home limit switch is no longer triggered. (One switch is required to stop anti-backlash)
Home using (Soft and Home Switches)	Motor will seek the home position by moving towards home switch but motor will slow down to base speed when the soft switch is triggered, followed by triggering the home switch to stop motion. (Two switches are required to stop)
Move number of steps	Motor will move number of steps entered.
Move to Position	Motor will move to specified position.
Slew	Motor will ramp up to maximum speed and keep moving until stop motion is triggered.
Stop Soft	Ramp motor down to base speed and stop.
Stop Hard	Stop any motor motion immediately.
Inputs	View inputs. (checked = On, blank = Off)
Outputs	View and trigger outputs. (checked = ON, blank = OFF)
Verify Parameters	Updates and displays controllers parameters sheet and resets the error codes.

# Tab Sheets - Encoder Options and Registration Inputs

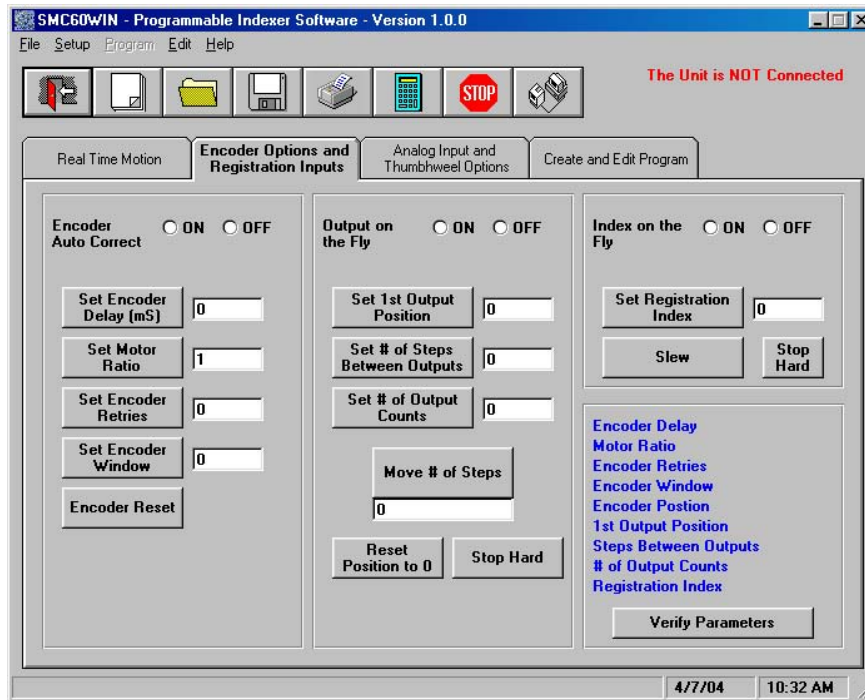

Encoder Auto Correct	Set the encoder autocorrect feature on or off.
Set Encoder Delay	Send the encoder delay parameter to the controller. (ms)
Set Motor Ratio	Send the encoder pulse to motor step ratio to the controller.
Set Encoder Retries	Send the number of encoder autocorrect retries to the controller. When the autocorrect errors, Output 8 will be triggered.
Set Encoder Window	Send the encoder window to the controller.
Encoder Reset	Reset the encoder count to 0 in the controller.
Output on the Fly	Set the output on the fly feature on or off.
Set 1st Output Position	Send the 1st position to set the output to the controller.
Set # of Steps Between Outputs	Send # of steps to take between activated outputs to the controller.
Set # of Output Counts	Send # of output counts to the controller.
Move # of Steps	Motor will move number of steps entered.
Reset Position to 0	Reset the controller position to 0 (zero).
Stop Hard	Stop any motor motion immediately.
Index on the Fly	Set the index on the fly feature on or off.
Set Registration Index	Send registration index to controller.
Slew	Motor will ramp up to maximum speed and keep moving until the index on the fly input is activated or a stop motion is triggered.
Stop Hard	Stop any motor motion immediately.
Verify Parameters	Updates and displays controllers parameters for this tab sheet.

## Tab Sheets - Analog Input and Thumbwheel Options

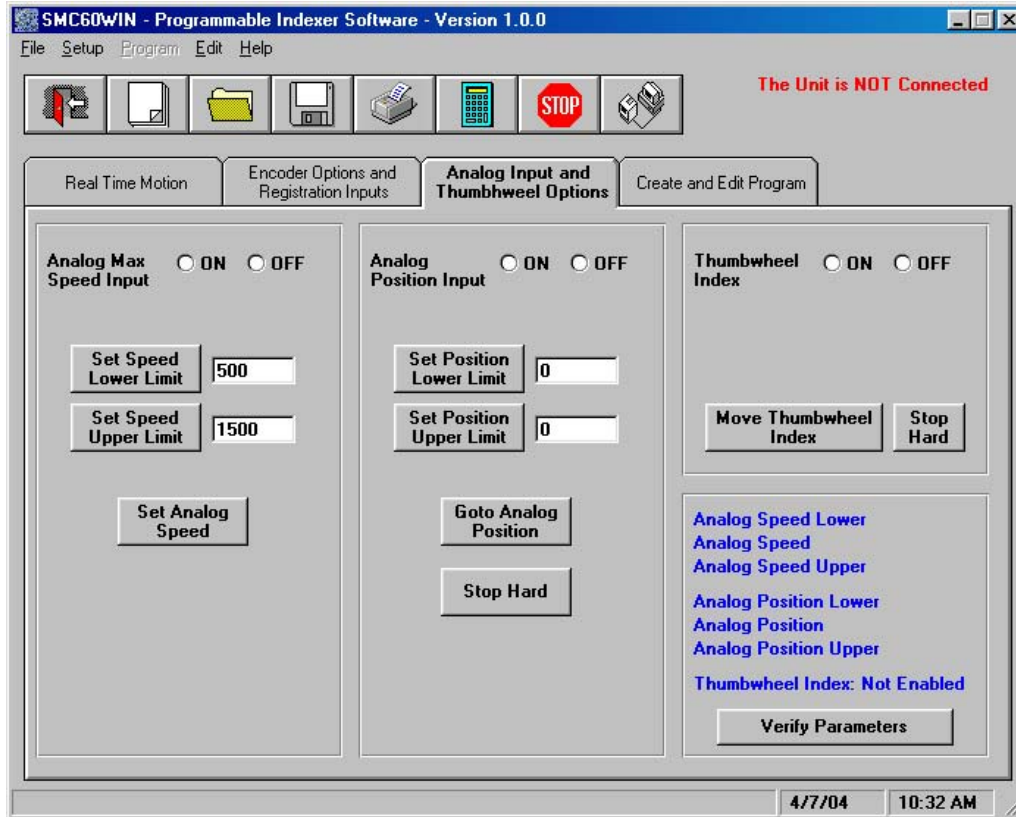

Analog Max Speed Input	Sets the analog speed input feature on or off.
Set Speed Lower Limit	Send the analog speed lower limit to the controller.
Set Speed Upper Limit	Send the analog speed upper limit to the controller.
Set Analog Speed	Sets the max speed based on analog voltage measured at input.
Analog Position Speed Input	Sets the analog position input feature on or off.
Set Position Lower Limit	Send the analog position lower limit to the controller.
Set Position Upper Limit	Send the analog position upper limit to the controller.
Set Analog Position	Motor will move to position based on analog voltage measured at input.
Stop Hard	Stop any motor motion immediately.
Thumbwheel Index	Sets the thumbwheel index feature on or off.
Move Thumbwheel index	Motor will move number of steps set by the thumbwheel switches.
Stop Hard	Stop any motor motion immediately.
Verify Parameters	Updates and displays controllers parameters for this tab sheet.

## Tab Sheets - Create and Edit Program

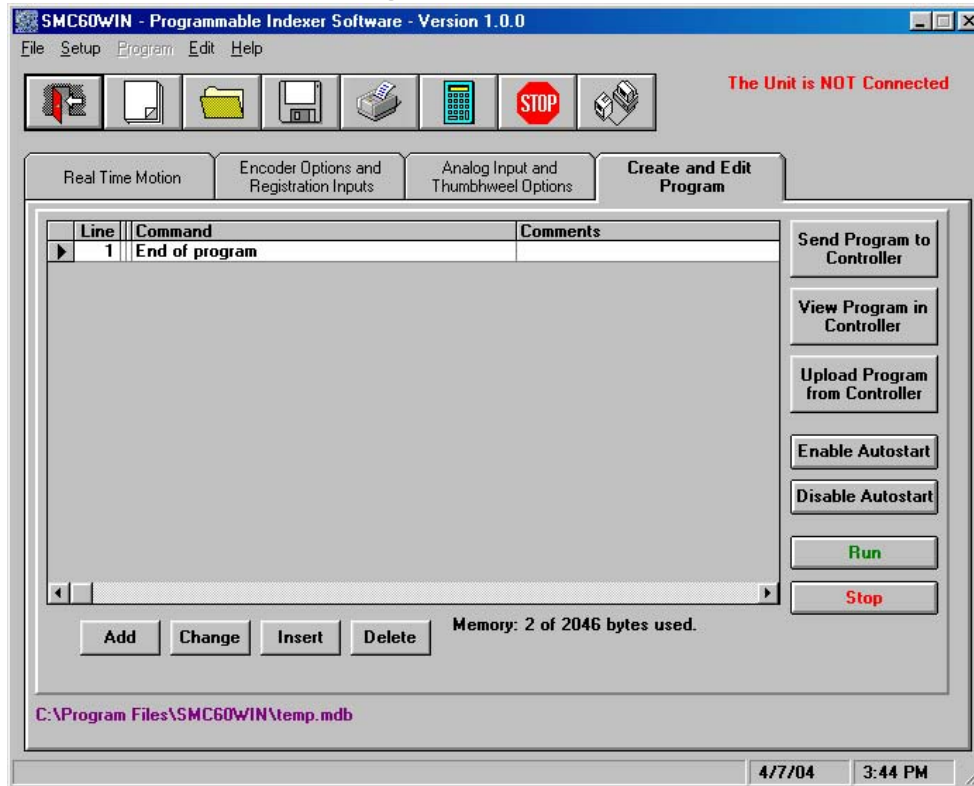

Send Program to Controller	Send current program to the controller.
View Program in Controller	View program in the controller memory.
Upload Program in Controller	Upload the program in the controller for editing and saving.
Enable Autostart	Program will start when controller is powered up.
Disable Autostart	Program will only execute when run is clicked.
Run	Execute the program in the controller memory.
Stop	Abort program execution.
Add	Adds a new line of code to the end of the program.
Change	Edits the currently selected line of code.
Insert	Insert a new line of code before the currently selected line of code.
Delete	Deletes the currently selected line of code.

### DPN10601 Memory Available

With the create and edit program tab sheet selected, the user can obtain the amount of available memory, located to the right of the Delete command button. The DPN10601 has a maximum available memory of 2046 bytes - each instruction can use from 2 to 7 bytes.

### Current Program Filename

With the create and edit program tab sheet selected, the user can obtain the current program filename, located in the lower left corner of the SMC60WIN window. All programs created by the SMC60WIN software will have a .mdb and a .bak extension.



## Currently Selected Line

The currently selected line is indicated in the program by the right pointing arrow/triangle in the left column. Clicking on any line will select a new currently selected line.

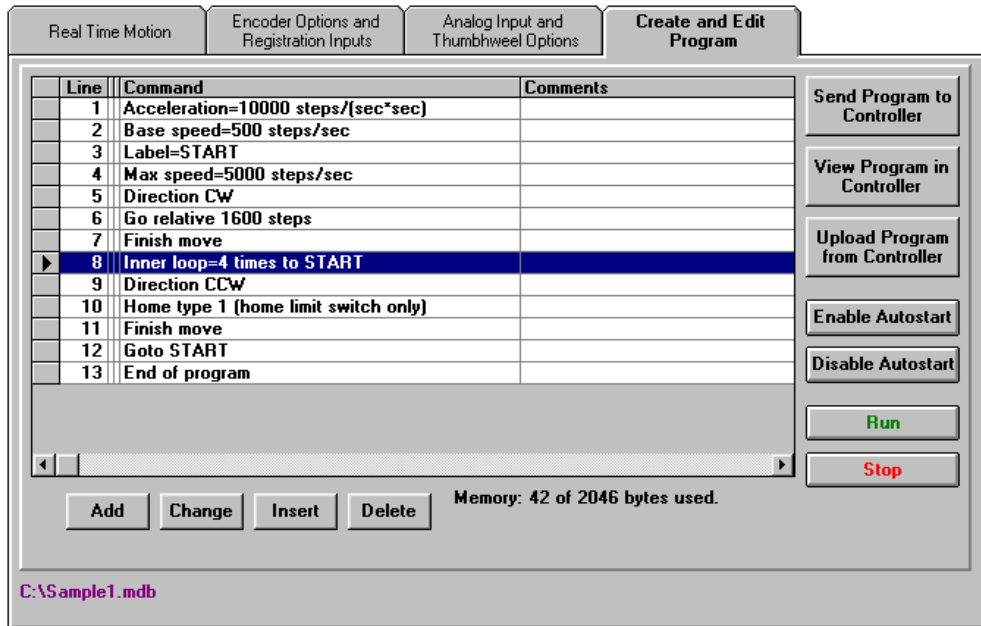

## Add/Change/Insert Commands

The Add/Change/Insert commands contain four different tab sheets, which are “Motion Commands”, “If/Then and Output Commands”, “Goto, For Loops, Encoder and Thumbwheel Commands” and “Analog, Registration and Text Commands”.



Motion Commands	Software section that allows user to enter speeds, positions, direction, etc.
If/Then and Output Commands	Software section that allows user to manipulate conditional statements and I/O routines.
Goto, For Loop, Encoder and Thumbwheel Commands	Software section that allows user to manipulate branching and loop routines ,enter encoder parameters and control the thumbwheel switches.
Analog, Registration and Text Commands	Software section that allow user to enter parameters for analog speed and position limits, index on the fly and output on the fly parameters and text strings to be sent.

These tab sheets is where the program functions are selected to be added to or to change existing lines of programming code in the Create and Edit Program tab.

- To add a line of motion control, select appropriate command, and if required, enter the required value for that particular command. Then, click **OK**.
- Comment is optional, for any lines of code.
- The text box above the **OK** and **Cancel** buttons will display useful information about each command.

## Add Tab Sheets - Motion Commands

Accel/Decel	Set program acceleration & deceleration parameter. (step/sec <sup>2</sup> )
Base Speed	Set program base (start) speed rate. (step/sec)
Max Speed	Set program maximum (running) speed rate. (step/sec)
Set Jog Speed	Set program jogging speed rate. (step/sec)
Set Position	Set motor position.
Direction CW (CCW)	Set direction to clockwise or counter-clockwise.
Motor Current ON (OFF)	Set the current in the motor on or off.
Wait ___ Milliseconds	This command allows the user to enter a delay in milliseconds.
Move ___ Steps	Relative move command will allow motor to move the defined number of steps entered.
Move to Position	Absolute move command will move motor to the position specified.
Set Position	Allows user to change the position register in the controller.
Finish Move	Command will allow any motion command to be completed before continuing to the next line of code. This command should be used after every motion command.
Repeat Last Move	Command will repeat the previous index move. Do not use with encoder autocorrect enabled.
Home to Soft, Home Limits	Command will begin motion in the direction last entered, seeking the soft input first to slow the motor down to base speed, then to stop when the home limit is triggered.
Home to Home Limit	Command will begin motion seeking the home limit which will slow the motor down to base speed, reverse the direction and stop when the home limit is no longer triggered.
Slew (move continuously)	Command will ramp motor up to max speed and keep moving until triggered to stop.
Stop Soft	Ramp motor down to base speed and stop.
Stop Hard	Stop any motor motion immediately.
End of Program	This command is required as the last command in the program code.



## Add Tab Sheets - If/Then and Output Commands

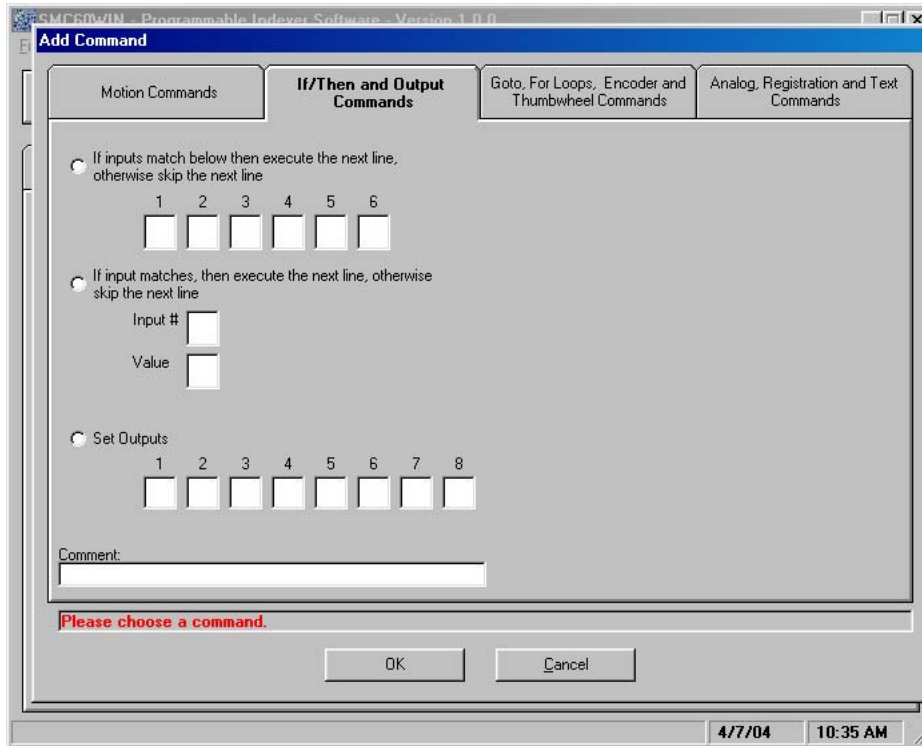

If inputs match below then execute the next line, otherwise skip the next line	This conditional command allows the user to execute the next line of code if the inputs triggered match the given value. If the inputs do not match, the next line is skipped.
If input matches, then execute the next line, otherwise skip the next line	This conditional command allows the user to execute the next line of code if the specific input triggered matches the given value. If the input does not match, the next line is skipped.
Set Outputs	The outputs can be turned (on=1) or (off=0). These outputs can be used to trigger PLC operations, relays, solenoids, etc.

## Add Tab Sheets - Goto, For Loops, Encoder and Thumbwheel Commands

Goto	Command allows the program to jump to the specified label.
Label	Command inserts a label for goto and loop commands.
Return from Subroutine	Command will return to the last goto and execute the next line of code.
Outer Loop	Command allows a sequence of commands to be looped a specific number of times to a label. This label must be before the outer loop command. This command cannot be used within an inner loop.
Inner Loop	Command allows a sequence of commands to be looped a specific number of times to a label. This label must be before the inner loop command. This command can be used within an outer loop.
Thumbwheel Index Off	Command will disable the ability to use the thumbwheel switches to index.
Thumbwheel Index On	Command allows the user to use the thumbwheel index. Switch 2 must be in the thumbwheel position for the thumbwheel to be enabled.
Move Thumbwheel Index	Relative move command will allow motor to move the defined number of steps set by the thumbwheel switches.
Encoder Auto Correct Off	Command will disable the autocorrect of the motor. The encoder value can still be read.
Encoder Auto Correct On	Command will enable the use of the encoder and autocorrect the motor if needed, based on the encoder registers.
Delay	Command sets a time delay used for settling time needed after an index is finished: The delay occurs before the encoder count is read.
Motor Ratio	Command sets the number of encoder counts to one motor step.
Retries	Command sets the number of times the motor can autocorrect itself before erroring. When the autocorrect errors, Output 8 will be triggered.
Window	Command sets the number of encoder counts the motor is allowed to be off.
Reset Encoder Count	Command will reset the encoder count to 0 (zero).

## Add Tab Sheets - Analog, Registration and Text Commands

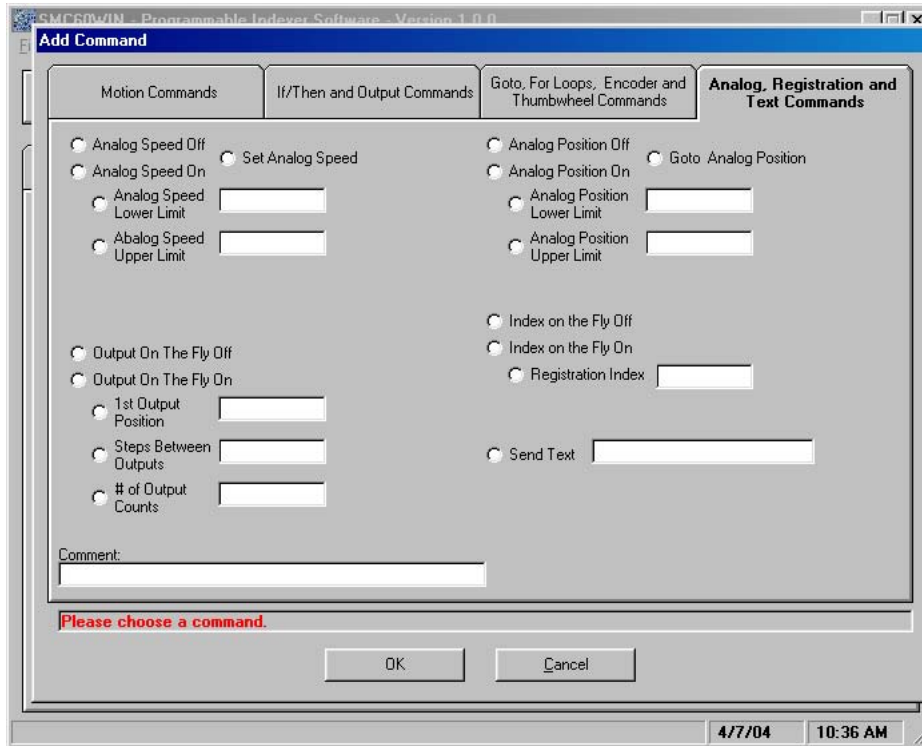

Analog Speed On (Off)	Sets the analog speed input feature on or off.
Set Analog Speed	Sets the maximum (running) speed based on the analog input.
Analog Speed Lower Limit	Sets the analog speed lower limit to the value specified.
Analog Speed Upper Limit	Sets the analog speed upper limit to the value specified.
Analog Position On (Off)	Sets the analog position input feature on or off.
Goto Analog Position	Motor will move to the position based on the analog input.
Analog Position Lower Limit	Sets the analog position lower limit to the value specified.
Analog Position Upper Limit	Sets the analog position upper limit to the value specified.
Output on the Fly On (Off)	Sets the output on the fly feature on or off.
1st Output Position	Sets the position that the 1st output will trigger during and index.
Steps Between Outputs	Sets the number of steps between the triggered output.
# of Output Counts	Set the number of times the output will trigger.
Index on the Fly On (Off)	Sets the index on the fly feature on or off.
Registration Index	Sets the value of the index that will occur after the registration input is activated.
Send Text	Will send the entered text string back to the user. (20 characters maximum)

# Calculator

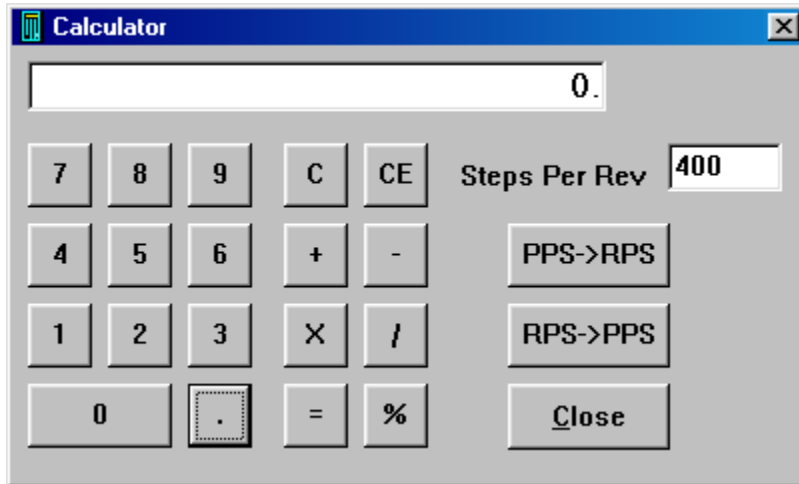

PPS->RPS	Convert from pulses per second to revolution per second.
RPS->PPS	Convert from revolution per second to pulses per second.
Steps Per Rev	Enter the number of steps per revolution of the step motor. The default is for a 200 step/rev motor in half step, which is equal to 400.
Close	Exit the Calculator.

## Section 5: Direct Talk Mode

Direct mode is used to directly control motion for real time movements through serial communication. The DPN10601 controller has 40 commands, which are easy to remember for direct movement of a step motor.

### COM Port Settings

**Baud Rate:** 38400  
**Data Bits:** 8  
**Parity:** None  
**Stop Bits:** 1  
**Flow Control:** Xon/Xoff

### Unit Selection

In order to select a unit, the @ command followed by the address of the unit must be sent.

NOTE: There should be no spaces between the @ and address select.

#### How to select a unit:

@0 (Unit 0 is selected)  
@1 (Unit 1 is selected)  
@29 (Unit 29 is selected)

#### How to get a response from a unit:

@0\$ (Carriage Return)

After the \$ command, the DPN10601 will return a SMC60 + the current revision number.

Note: In direct talk mode each command is followed by a carriage return.

The unit communicates in half duplex mode, therefore proper setup of hyper terminal is necessary to view characters, if characters are to be echoed back to the screen.

### Instructions

All instructions require that no spaces be sent between the command and the parameter followed by a carriage return.

@0 not @ 0 correct: @0(carriage return)  
incorrect: @ 0 (carriage return)

#### Command Summary:

A - Acceleration/Deceleration	M - Max speed	+ - Clockwise direction
B - Base speed	N - Number of steps	, - Stop soft
C - Steps between outputs	O - Set outputs	-- - Counterclockwise direction
D - 1st output on the fly position	P - Absolute position	. - Stop hard
EA - Encoder autocorrect enabled	S - Go slew	/ - Thumbwheel enabled
ED - Encoder delay	T - Motor current enabled	: - Analog position enabled
EM - Encoder motor ratio	V - Verify	; - Analog speed enabled
ER - Encoder retries	Z - Position	[ - Analog speed lower limit
ET - Encoder reset	! - Error codes register	] - Analog speed upper limit
EW - Encoder window	\$ - Version number	^ - Number of outputs
G - Go number of steps	% - Verify axis number	{ - Analog position lower limit
H - Home	' - Index on the fly enabled	} - Analog position upper limit
I - Read inputs	( - Output on the fly enabled	~ - Set address of DPN10601
J - Fast jog speed		

## **A - Acceleration/Deceleration**

Format: A[value]

Description: This command sets the acceleration profile which is an integer value between 100 and 9,999,999. The higher the value, the faster the motor acceleration.

Range: 100 - 9,999,999

## **B - Base speed**

Format: B[value]

Description: This command sets the base (start) speed for motion. This value must be set before motion begins and be less than the maximum speed and fast jog speed.

Range: 1 - 5000

## **C - Number of steps between outputs during output on the fly**

Format: C[value]

Description: This command sets the number of steps between when output 1 turns on during an output on the fly move. If only one output turn on is needed, set this value to 0. This command is used in conjunction with the output on the fly enabled “(“ command.

Range: 0 - 65535

## **D - 1st Output on the fly position**

Format: D[value]

Description: This command sets the position at which output 1 will turn on during an output on the fly move. This command is used in conjunction with the output on the fly enabled “(“ command.

Range: 0 - 65535

## **EA - Encoder autocorrect enabled**

Format: EA[0 or 1]

Description: This command will either enable or disable the encoder autocorrect function. To enable the function use a 1, to disable the function use a 0. When this function is enabled, the relative register is used to calculate the encoder position, therefore before the next move is made, the relative register needs to be set. This command is used in conjunction with the encoder delay “ED”, encoder ratio “EM”, encoder retries “ER” and encoder window “EW” commands.

### **ED - Encoder delay**

Format: ED[value]

Description: This command sets the wait time a specified number of milliseconds after a relative index or absolute move is finished, before reading the encoder. This is used to remove the ringing that might be associated with the mechanics of the system. This command is used in conjunction with the encoder autocorrect "EA" command.

Range: 0 - 65535

### **EM - Encoder motor ratio**

Format: EM[value]

Description: This represents the ratio for the number of encoder pulses to one motor step. An example is for a 1000 line quadrature encoder and a 400 step/revolution motor, the motor ratio is  $(1000 * 4) / 400 = 10$ . This command is used in conjunction with the encoder autocorrect EA command.

Range: 1 - 255

### **ER -Encoder retries**

Format: ER[value]

Description: This is the number of times the DPN10601 controller will try to autocorrect the motor before erroring. This command is used in conjunction with the encoder autocorrect EA command. When the autocorrect errors, Output 8 will be triggered.

Range: 0 - 255

### **ET - Encoder reset**

Format: ET

Description: This command will reset the internal encoder count register to 0.

### **EW -Encoder window**

Format: EW[value]

Description: This is the allowable error in encoder pulses (either plus or minus) from the desired position that is allowed before the motor autocorrects. This command is used in conjunction with the encoder autocorrect EA command.

Range: 0 - 255

## **G - Go number of steps**

Format: G

Description: This command is used to send a set number of clocks out of the DPN10601 controller. An N or P command must be entered before the G command. The ramp profile is specified by the B (base speed), M (max speed), and A (acceleration/deceleration) commands.

## **H - Home**

Format: H[0 or 1]

Description:

Home Types: H0: In type 0 homing, the DPN10601 will send clocks until a soft limit is reached, then ramp down to base speed. Clocks will continue at base speed until a home limit is reached. The ramp profile is specified by the B (base speed), M (max speed),

H1: In type 1 homing, the DPN10601 will send clocks until a home limit is reached, ramp down to base speed, change directions and run at base speed until the release of the home limit input. The ramp profile is specified by the B (base speed), M (max speed), and A (acceleration/deceleration) commands.

## **I - Read inputs**

Format 1: IR

Description: This command returns the binary value of the inputs to the PC. Since the inputs are pulled up internally (except input 1), they will return a high when they are open. For example; if all inputs are active (grounded), the command will return a 0. If all inputs are inactive (open), the command will return a 63. Input 1 is the LSB

Format 2: I[input]

Description: This command returns the value of the selected input to the PC. If the input is open or high it will return a 1. If the input is grounded or low it will return a 0.

Ranged: 0 - 6

## **J - Fast jog speed**

Format: J[value]

Description: This command sets the fast jog speed. This value must be set before motion begins and be greater than the base speed.

Range: 1 - 50000



## **M - Max speed and analog speed**

Format 1: M[value]

Description: This command sets the maximum (running) speed for motion. This value must be set before motion begins, and be greater than the base speed.

Range: 1 - 50000

Format 2: M

Description: This command uses the voltage on input 1 to calculate and set the max speed. The analog speed must be enabled for this command to work. This command is used in conjunction with the analog speed “;”, the analog speed lower limit “[”, and the analog speed lower limit “]” commands. This value must be set before motion begins.

## **N - Number of steps**

Format 1: N[value]

Description: This command sets the number of clocks for the DPN10601 to send out following a G command. It is also used to set the registration index during and index on the fly move. Motion is not activated by this command; it only sets the index register.

Range: 0 - 8388607

Format 2: N

Description: This command reads the thumbwheel switches to set the number of clocks for the DPN10601 to send out following a G command. For this command to work the thumbwheel enable bit must be enabled. Motion is not activated by this command, it only sets the index register. This command is used in conjunction with the thumbwheel enabled “/” command.

## **O - Set outputs**

Format 1: OR[value]

Description: This command sets the output register according to the binary value entered. Output 1 is the LSB and output 8 is the MSB.

Range: 0 - 255

Format 2: O[output]=[0 or 1]

Description: This command sets the selected output either on or off. A 1 will turn the output on (0VDC) and a 0 will turn the output off (open).

Range: 0 - 8

## **P - Absolute position and analog position**

Format 1: P[value]

Description: This command calculates and sets the number of clocks for the DPN10601 to send out following a G command. Motion is not activated by this command; it only sets the register. ( $N = P - Z$ )

Range: -8388607 to +8388607

Format 2: P

Description: This command uses the voltage on input 1 to calculate and set the number of clocks for the DPN10601 to send out following a G command. The analog position must be enabled for this command to work. Motion is not activated by this command, it only sets the register ( $N = P - Z$ ). This command is used in conjunction with the analog position “:”, the analog position lower limit “{“, and the analog position lower limit “}” commands.

## **S - Go slew**

Format: S

Description: This command will send clocks out to the DPN10601. The only commands that can stop the clocks are; “.” (stop motion) or “,” (soft limit). Motion can also be stopped by using the limit switch inputs. The ramp profile is specified by the B (base speed), M (max speed), and A (acceleration/deceleration) commands.

## **T - Motor current enabled**

Format: T[0 or 1]

Description: This command will control the On/Off output, which is designed to connect to the on/off input of Anaheim Automation’s step motor drivers. To energize and allow current to flow through the coil of the motor, set the value to 1. To de-energize and turn the current off to the motor, set the value to 0. This is a dedicated output, and not controlled with the output register.

## V - Verify

Format: V[command]

Description: This command can be used with most commands to verify the register contents. This is a read only command. Valid Commands are shown below.

Command	Description	Command	Description
A	Verify acceleration/deceleration	O	Verify outputs
B	Verify base speed	T	Verify motor current (1 is on, 0 is off)
C	Verify steps between outputs on the fly	Z	Verify position
D	Verify 1st output on the fly position	'	Verify index on the fly enabled**
EA	Verify encoder autocorrect enabled**	(	Verify output on the fly enabled**
ED	Verify encoder delay	+	Verify Direction
EM	Verify encoder motor ratio	/	Verify thumbwheel index enabled**
EP	Verify encoder position	:	Verify analog position enabled**
ER	Verify encoder retries	;	Verify analog speed enabled**
EW	Verify encoder window	[	Verify lower analog speed value
F	Verify if controller is busy (1 is busy, 0 is not busy)	]	Verify upper analog speed value
J	Verify jog speed	^	Verify number of outputs
L	Verify Limits (1 is Hard, 2 is Soft, 3 is Hard and Soft, 0 is neither)	{	Verify lower analog position value
M	Verify max speed	}	Verify upper analog position value
N	Verify number of steps		** 1 is enabled, 0 is disabled

## Z - Position

Format: Z[value]

Description: This command sets the current position as a reference. This register can contain a positive or negative value but, cannot be changed while motion is in progress.

Range: -8388607 to +8388607

## ! - Error codes register

Format: !

Description: This command requests the DPN10601 controller to get the current error code and print it to the screen. For a description of the error codes see page 39.

## \$ - Version number register

Format: \$

Description: This command requests the DPN10601 controller to return its internal firmware version number.

### **% - Verify address register**

Format:       %       (No address is needed before this function. @% will return the address)

Description:   This command requests the DPN10601 controller to return its internal address number to the PC or PLC.

### **' - Index on the fly enabled**

Format:       '[0 or 1]

Description:   This command will either enable or disable the index on the fly function. To enable the function, use a 1. To disable the function use a 0. This command is used in conjunction with the number of steps "N" and go slew "S" commands.

### **( - Output on the fly enabled**

Format:       ([0 or 1]

Description:   This command will either enable or disable the output on the fly function. To enable the function, use a 1. To disable the function use a 0. This command is used in conjunction with the number of steps between outputs "C", 1st output position "D", and number of outputs "^" commands.

### **+ - Clockwise**

Format:       +

Description:   This command sets the direction output to clockwise.

### **, - Soft Limit Input Bit**

Format:       ,

Description:   This command will ramp the clocks down to base speed. The move type then determines what will happen. In a relative or absolute type motion the DPN10601 controller will continue to the set position and stop. In a slew type motion the DPN10601 controller will ramp down and stop. In a home type motion the DPN10601 controller will ramp down and run at base speed, until the home limit is activated.

### **-- Counter-Clockwise**

Format:       -

Description:   This command sets the direction output to counterclockwise.

### **. - Stop Motion**

Format:       .

Description:   This command will stop all motion. It can also be used to stop the current program that is running.

### **/ - Thumbwheel index enabled**

Format:       /[0 or 1]

Description: This command will either enable or disable the ability to use the thumbwheel switches for indexing.

### **: - Analog position enabled**

Format:       :[0 or 1]

Description: This command will either enable or disable input 1 to be used to set the analog position. To enable the function, use a 1. To disable the function use a 0. This command is used in conjunction with the analog position lower limit "{" and analog position upper

### **; - Analog speed enabled**

Format:       ;[0 or 1]

Description: This command will either enable or disable input 1 to be used to set the analog speed. To enable the function, use a 1. To disable the function use a 0. This command is used in conjunction with the analog speed lower limit "[" and analog speed upper

### **[ - Analog speed lower limit**

Format:       [[value]

Description: This command sets the lower limit that is used during the calculation following an M command for the analog speed input. This command is used in conjunction with the analog speed enabled ";" and max speed "M" commands.

Range:       1 - 50000

### **] - Analog speed upper limit**

Format:       ][value]

Description: This command sets the upper limit that is used during the calculation following an M command for the analog speed input. This command is used in conjunction with the analog speed enabled ";" and max speed "M" commands.

Range:       1 - 50000

#### **^ - Number of outputs during output on the fly**

Format:        ^[value]

Description:   This command sets the number of times output 1 will turn on during an output on the fly move. This command is used in conjunction with the output on the fly enabled "(" command.

Range:         0 - 255

#### **{ - Analog position lower limit**

Format:        {[value]

Description:   This command sets the lower limit that is used during the calculation following a P command for the analog position input. This command is used in conjunction with the analog position enable ":" and absolute position "P" commands.

Range:         0 - 65535

#### **} - Analog position upper limit**

Format:        }[value]

Description:   This command sets the upper limit that is used during the calculation following a P command for the analog position input. This command is used in conjunction with the analog position enable ":" and absolute position "P" commands.

Range:         0 - 65535

#### **~ - Set address register**

Format:        ~[value] (No address is needed before this function. @~[value] will set the address)

Description:   This command sets the address for communication inside the DPN10601.

Range:         0 - 99

## Section 6: Troubleshooting

### Problem:

Cannot establish communications with the DPN10601.

### Possible Solutions:

- 1) Make sure the DPN10601 controller has power. Is the controller's Green LED on ?
- 2) Check the RS232/RS485 connections.
- 3) Check for loose cable connections either on the DPN10601 controller or COM Port.
- 4) Was the software installed successfully?
- 5) Go to **Setup | Com Port Settings** and verify COM port setting.
- 6) Go to **Setup | Axis** and verify address settings are the same.
- 7) Click on **Setup | Connect** icon to communicate with the DPN10601 controller.
- 8) If problems still exist, contact Anaheim Automation Tech Support.

Anaheim Automation  
Technical Assistance

910 E Orangefair Lane  
Anaheim, CA 92801, USA  
[www.anaheimautomation.com](http://www.anaheimautomation.com)  
[sales@anaheimautomation.com](mailto:sales@anaheimautomation.com)

### Problem:

There is no power to the DPN10601 controller.

### Possible Solutions:

- 1) Is the DPN10601 controller connected to the appropriate power supply?
- 2) Check for any blown fuses in line with the DPN10601 controller.
- 3) If problems still exist, contact Anaheim Automation, Inc. Tech Support.

### Problem:

My program won't "Autostart".

### Possible Solutions:

- 1) Verify that the Autostart Function has been enabled.
- 2) Go to **Setup | Autostart Program** and Click on **Enable**.
- 3) If problems still exist, contact Anaheim Automation Tech Support.

**Problem:**The DPN10601 controller has a fault condition.

**Possible Solutions:**

- 1) Verify your program for improper syntax that may cause an error code.
- 2) Physically press the reset button on the DPN10601 to clear an error.
- 3) Another way to clear an error is by using either the SMC60WIN software or the direct mode command instructions set.
- 4) The SMC60WIN can clear an error in the real time motion tab section by clicking on the verify parameters button.
- 5) The direct mode command “!” can clear an error by simply prompting the error code register to return the value back to the PC or PLC.

Note: Read the Error returned to the screen to better understand what can be causing the fault condition. The error is returned in binary coded decimal format. If two errors were received, their binary values would be added together.

**Error Codes**

Error Code	Type	Description
1	Receive Overflow Error	The serial communications had a receiving error. This is an internal error caused by the computer.
2	Encoder Error 1	The encoder needed to correct the index.
4	Encoder Error 2	The encoder could not finish the index. Output 8 is set with this error.
8	Command Error	A bad command was sent to the controller. Please check to see that the command being sent is valid.
16	Motor Error	Motor speed profiles are set incorrectly. Please make sure that the base speed is less than the max speed and that the speeds are within their valid ranges.
32	Range Overflow Error	The go to position has an overflow error. This is caused by the P command trying to find a position that is out of its range.
64	Range Error	There was an invalid number of commands and characters sent to the controller. Check to see if the parameters are invalid for the command that was sent.
128	Transmitt Error	To many parameters sent back to the PC. This is an internal error caused by the eeprom.
256	Mode Error	Controller is in a wrong mode. Some commands are good only in programming mode, while others are good only in direct mode. Check the direct mode section to see which commands are good in direct mode.
512	Zero Parameters Error	There were no parameters sent to the controller. A command was sent to the controller that expected to see parameters after the command.
1024	Busy Error	The controller is busy indexing. The controller is sending out clocks to the driver and can not execute the next instruction.
2048	Memory Range Error	The specified address is out of range. This is caused by overflowing the program memory by having a program that is to large.
4096	Memory Command Error	The command pulled from memory is invalid. The command that was stored into the eeprom was non executable by the program. This is an internal error.
8192	Thumbwheel Read Error	There was an error reading the thumbwheel or the thumbwheel is not present.



# Section 7: Sample Programs

## Sample Program 1:

Sample Program 1 illustrates a typical application where a system moves to a specific position required. The sample program shows how to use the motion and goto instruction commands.

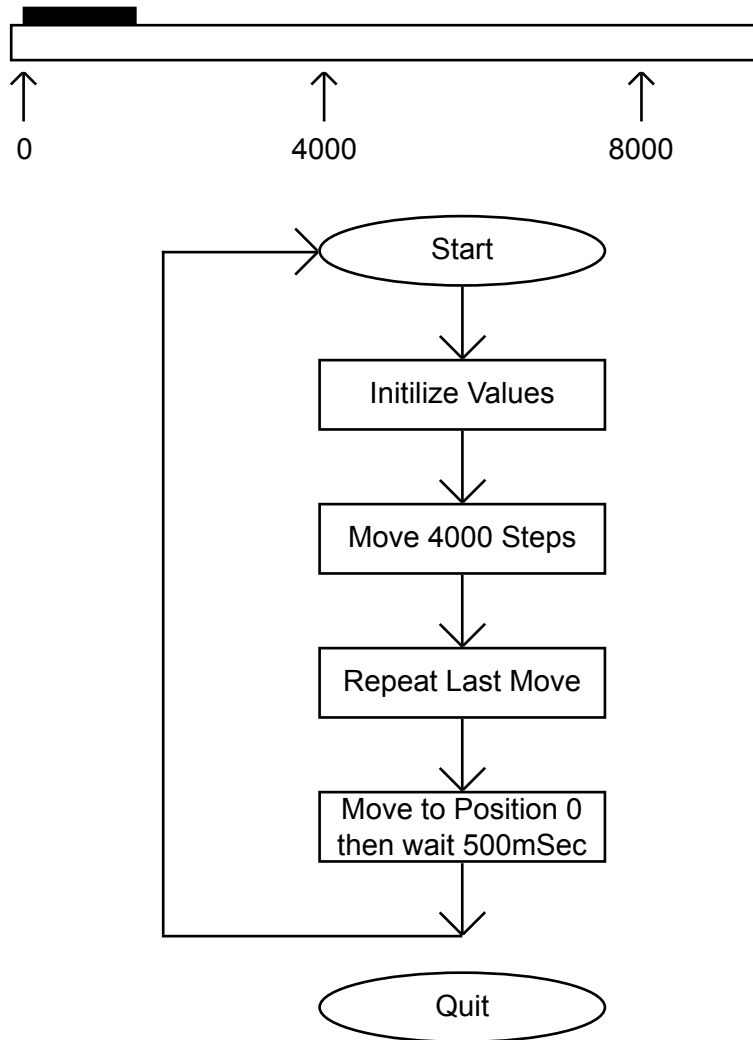

Line	Command	Comments
1	Acceleration=1000 steps/(sec*sec)	
2	Base speed=500 steps/sec	
3	Max speed=5000 steps/sec	
4	Position register=0	
5	Label=TOP	
6	Direction CW	
7	Go relative 4000 steps	Move to 1st position
8	Finish move	
9	Repeat last index	Move to 2nd Position
10	Finish move	
11	Go to position 0	Return to Zero Position
12	Wait 500 msec	Wait 0.5 Seconds
13	Goto TOP	Repeat moves
▶ 14	End of program	

## Sample Program 2:

Sample Program 2 illustrates a typical application where a system is first sent home to a datum or 0 position. This sample program shows how a motor will move to 3 different positions utilizing some of the motion commands, loop routines and encoder routine.

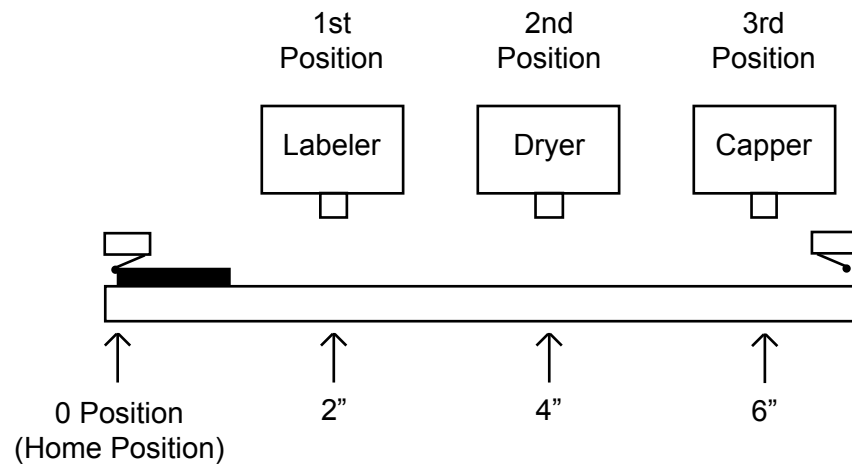

Line	Command	Comments
1	Acceleration=1000 steps/(sec*sec)	
2	Base speed=500 steps/sec	
3	Max speed=5000 steps/sec	
4	Encoder delay=10 msec	Wait 10mS for encoder ringing
5	Encoder motor ratio=110 counts/step	1000 Lines: 400 step/rev
6	Encoder retries=3	Allow three retries
7	Encoder window=10 counts	Allow 1 motor step error
8	Turn on encoder autocorrect	
9	Label=TOP	
10	Direction CCW	
11	Home type 1 (home limit switch only)	Home to a physical switch
12	Finish move	
13	Position register=0	Reset position register to 0
14	Reset the encoder position to 0	Reset the encoder count
15	Direction CW	
16	Go relative 4000 steps	Move to 1st Position
17	Finish move	
18	Go relative 4000 steps	Move to 2nd Position
19	Finish move	
20	Wait 1000 msec	
21	Go relative 4000 steps	Move to 3rd Position
22	Finish move	
23	Outer loop=3 times to TOP	
24	End of program	

### Sample Program 3:

Sample Program 3 illustrates the setup and operation of the output on the fly function, and the use of the if/then statement. The system is first homed using home type 0, waits for input 1 to be a value of 0 (grounded) and then is indexed 10,000 steps. During this index, output 1 needs to be turned on every 1000 steps 5 times starting at position 2000. At the end of the index, output 1 is then turned on again for 1 mS and the unit is then sent back the 10,000 steps to position 0, but the output should not be turned on. The unit then repeats waiting for input 1 to be 0 and indexes again.

Line	Command	Comments
1	Acceleration=1000 steps/(sec*sec)	
2	Base speed=500 steps/sec	
3	Max speed=5000 steps/sec	
4	Direction CCW	
5	Home type 0 (soft and home switch)	
6	Finish move	
7	Position register=0	
8	Output on at position=2000	
9	Steps between outputs=1000 steps	
10	# of output counts=5	
11	Label=TOP	
12	If input 1=1, then execute the next line	Loop to TOP until input 1 is 0
13	Goto TOP	
14	Enable output on the fly	
15	Direction CW	
16	Go relative 10000 steps	
17	Finish move	
18	Output register=1	Turn on Output 1
19	Wait 1 msec	
20	Output register=0	Turn off Output 1
21	Disable output on the fly	
22	Go to position 0	
23	Finish move	
24	Goto TOP	
▶ 25	End of program	

## Sample Program 4:

Sample Program 4 illustrates the setup of the analog speed function and the use of “indexing-on-the-fly.” The system is first homed using home type 1. The next step is to wait for the input register to read 110111 (input 2 must be high while input 3 is low, all other inputs are not used and input 1 is masked high due to the analog function being used). The third step is to slew using the analog input as the maximum speed between 5000 and 10000 steps/revolution. When input 2 is switched low, the unit will index 2500 more steps and ramp down to base speed and stop. At the end of the index, output 1 will turn on for 100 mS. After the output is turned off the unit will be sent back to position 0. The program then is sent back to repeat itself, waiting for the input register to be 110111 again.

Line	Command	Comments
1	Acceleration=1000 steps/(sec*sec)	
2	Base speed=500 steps/sec	
3	Analog speed lower limit=5000 steps/sec	
4	Analog speed upper limit=10000 steps/sec	
5	Enable analog speed	
6	Enable index on the fly	
7	Direction CCW	
8	Home type 1 (home limit switch only)	Home to a physical switch
9	Finish move	
10	Position register=0	Reset position register to 0
11	Label=TOP	
12	If input register=59, then execute the next line	Input 2 high, Input 3 low
13	Goto INPUTGOOD	
14	Goto TOP	
15	Label=INPUTGOOD	
16	Get max speed from analog input	
17	Registration index=2500 steps	
18	Direction CW	
19	Slew	
20	Finish move	
21	Output register=1	Turn output 1 on
22	Wait 100 msec	
23	Output register=0	Turn output 1 off
24	Go to position 0	
25	Finish move	
26	Goto TOP	
27	End of program	

## Sample Program 5:

Sample Program 5 illustrates a typical 3 axis application where one DPE25601 (Axis 0) is controlling the other two axes (Axis 1 and Axis 2) by using the send text string commands. The program first sets the accelerations, base speeds and maximum speeds for each axis. It then is enabling Axis 0 and Axis 1 to use the thumbwheel switch that is connected to each unit for indexing. The direction is then set for Axis 0 and Axis 1 and these two axes are then told to index the distance set in each thumbwheel at the same time. The program then waits for the motion to finish before it tells Axis 2 to move. Axis 2 first moves in the negative direction waits for the index to finish, and then moves back in the positive direction. After Axis 2 is finished moving, Axis 0 and Axis 1 are both sent back to their zero positions at the same time. The program is then repeated.

Line	Command	Comments
1	Acceleration=1000 steps/(sec*sec)	Axis0 Accel = 1000
2	Send Text String @1A1000	Axis1 Accel = 1000
3	Send Text String @2A100	Axis2 Accel = 100
4	Base speed=500 steps/sec	Axis0 Base = 500
5	Send Text String @1B500	Axis1 Base = 500
6	Send Text String @2B100	Axis2 Base = 100
7	Max speed=5000 steps/sec	Axis0 Max = 5000
8	Send Text String @1M5000	Axis1 Max = 5000
9	Send Text String @2M500	Axis2 Max = 500
10	Enable thumbwheel	Enable Axis0 Thumbwheel
11	Send Text String @1/1	Enable Axis1 Thumbwheel
12	Label=TOP	
13	Direction CW	Axis0 CW
14	Send Text String @1+	Axis1 CW
15	Send Text String @1N	Set Distance with thumbwheel
16	Go relative thumbwheel index	Axis0
17	Send Text String @1G	Axis1 Go relative thumbwheel
18	Finish move	Wait for moves to end
19	Wait 500 msec	
20	Send Text String @2-	Axis2 CCW
21	Send Text String @2N400	Set axis2 index
22	Send Text String @2G	Axis2 go relative
23	Wait 5000 msec	
24	Send Text String @2+	Axis2 CW
25	Send Text String @2G	Axis2 go relative
26	Wait 1000 msec	
27	Send Text String @1P0	Axis1 set goto position 0
28	Go to position 0	Axis0 Go to position 0
29	Send Text String @1G	Axis1 Go to position 0
30	Finish move	Wait for moves to end
31	Wait 1000 msec	
32	Goto TOP	Return and repeat
▶ 33	End of program	

## Appendix: ASCII Table for Direct Mode

ASCII Symbol	Hex Value	ASCII Symbol	Hex Value	ASCII Symbol	Hex Value
0	30	J	4A	#	23
1	31	K	4B	\$	24
2	32	L	4C	%	25
3	33	M	4D	"	27
4	34	N	4E	(	28
5	35	O	4F	+	2B
6	36	P	50	,	2C
7	37	Q	51	-	2D
8	38	R	52	.	2E
9	39	S	53	:	3A
A	41	T	54	;	3B
B	42	U	55	@	40
C	43	V	56	[	5B
D	44	W	57	]	5D
E	45	X	58	^	5E
F	46	Y	59	{	7B
G	47	Z	5A	}	7D
H	48	Carriage Return	0D	~	7E
I	49	!	21		